

Guidelines of Implementation for EDIFACT-Subset

EDITEC INVRPT/D.96 B
„Inventory Report“



Deutscher Großhandelsverband Haustechnik e.V.



ARGE Neue Medien
der deutschen SHK-Industrie e. V.



Version 3.2 / April 2004

Table of Contents – Guidelines of Implementation for Subset INVRPT/Inventory Report

Guidelines of Implementation.....	1
for.....	1
EDIFACT-Subset.....	1
EDITEC INVRPT/D.96 B.....	1
„Inventory Report“.....	1
Version 3.2 / April 2004.....	1
Table of Contents – Guidelines of Implementation for Subset INVRPT/Inventory Report.....	1
1 INTRODUCTION.....	2
1.1 Preconditions.....	3
1.2 Common Terms.....	4
2 EXPLANATION TO INVENTORY REPORT.....	5
2.1 General Explanation.....	5
2.2 Potentials of Use for Industry and Trade.....	5
2.3 Description of the Process.....	6
2.4 Terms Concerning the Inventory Report.....	8
3 RECOMMENDATIONS/EXAMPLES FOR PRACTICAL REALISATION.....	9
3.1 Model Examples.....	11
3.2 Model 1: Goods in stock/Stocking-up supply with information on goods receipt ...	12
3.2.1 Data for Model 1.....	12
3.2.2 Rules for Model 1.....	12
3.3 Model 2: Goods in Stock/Stocking-Up Supply with Open Purchase Order Quantity	14
3.3.1 Data for Model 2.....	14
3.3.2 Differences to Model 1:.....	14
3.3.3 Rules Model 2.....	14
3.3.4 Data for Model 3.....	16
3.3.5 Differences to Model 1 and Model 2.....	16
3.3.6 Rules Model 3.....	16
4 LAGERBESTANDBERICHT VON INDUSTRIE AN HANDEL.....	18
4.1 Zweck	18
4.2 Anwendungsbeispiel / Notwendigkeit.....	18

1 Introduction

The Guidelines of Implementation at hand concern the EDIFACT-Subset Version 3.2 „IN-VRPT (Inventory Report)“ was provided by ITEK on behalf of Deutscher Großhandelsverband Haustechnik e. V. and ARGE Neue Medien der Deutschen SHK-Industrie e. V.



Technologiepark 19
D - 33100 Paderborn

Telephone: (0 52 51) 8 72 88-0
Facsimile: (0 52 51) 8 72 88-19
E-Mail: arge@arge.de



Viktoriastrasse 27
D - 53173 Bonn

Telephone: (02 28) 62 905-0
Facsimile: (02 28) 62 905-20
E-Mail: info@dg-haustechnik.de



Technologiepark 19
D - 33100 Paderborn

Telephone: (0 52 51) 16 14 -0
Facsimile: (0 52 51) 16 14 -99
Email: editec@itekmbh.de

The Guidelines of Implementation are based on EDIFACT-Subset INVRPT Version 3.2.

1.1 Preconditions

In the SHK-branch, the standardisation of business messages on the level of sales and distribution between industry and wholesale trade began already ten years ago. During the past years, the process chain from order to the advice of settlement was further completed. The following diagram gives an overview of the standardised messages:

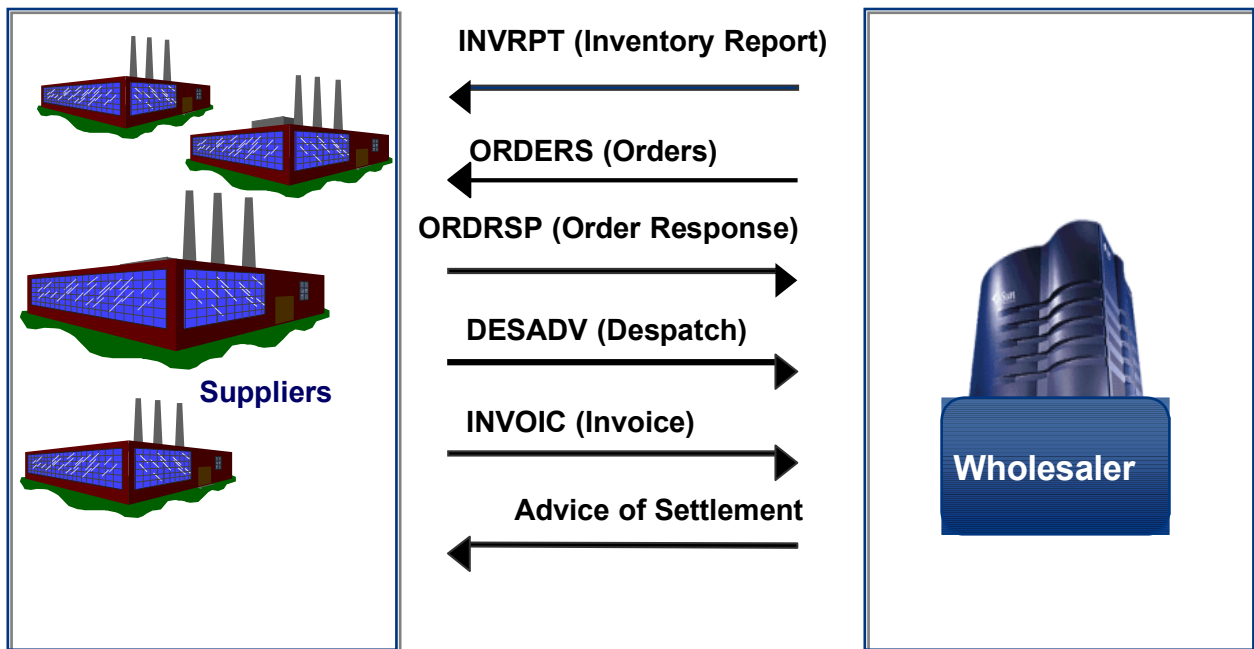

A prerequisite for the usage of the Invoice Report is the usage of Despatch advice (DESADV) or of Orders (ORDERS) and the Order Response (ORDRSP), Version 3.1 or higher. These messages were altered and completed accordingly in the process of the standardisation of the Inventory Report.

1.2 Common Terms

Listed and defined in the table below are the terms for the whole electronic data exchange as they are used by the SHK-branch:

Terms	Definition
Goods in stock	Articles marked as stock. The wholesaler functions as the stockist.
Procured Products	Articles not marked as stock which have to be ordered separately in case of need
Object Business	Special demand for objects which are not covered by the stock of inventory.
Third-Party Deal	Special demand, which is delivered to the wholesaler's client by the industry.
Static Assortment	A fixed range of products defined between industry and wholesale trade. Alterations are processed only on mutual agreement. In case of the transfer of static assortments, articles other than those defined are controlled by the industry.
Dynamic Assortment	The range of products of the Dynamic Assortment is defined by the articles transferred in the Inventory Report.

2 Explanation to Inventory Report

2.1 General Explanation

With the Inventory Report, the inventory data of a certain inventory assortment that has been agreed on before by wholesale trade and producer is transferred. This report is transferred in periodic intervals that have to be mutually pre-defined.

2.2 Potentials of Use for Industry and Trade

The following table shows the potentials of using Inventory Report for industry and trade:

Trade	Industry
✓ Stock reduction	✓ Improval of control and outlet control
✓ Increased capacity of delivery	✓ Increased capacity of delivery
✓ Reduction of the flow costs at the goods receipt	✓ Production control adequate to the demands
✓ Reduction of administrative efforts for disposals	✓ Increase of market knowledge (information at an early stage)
✓ Improvement of the adjustment of the assortment (applies to the local market as well)	✓ Consideration of the packaging units
✓ Continuous deliveries by the industry	✓ Continuous deliveries to the trade

The purpose is that the industry arranges the inventory assortment agreed upon for the wholesale trade. This shall happen on the basis of the contents transferred in the Inventory Report. The arrangement of this assortment is thus processed on the basis of the parameters mutually agreed upon.

2.3 Description of the Process

This basic change in the course of the business process consequently affects other messages as well. Thus, orders concerning the mutually predefined inventory assortment of goods in stock are not activated by the wholesale trade anymore, but the industry detects the demand and defines the delivery quantities.

The following process applies to the automatic stock arrangement by the producer:

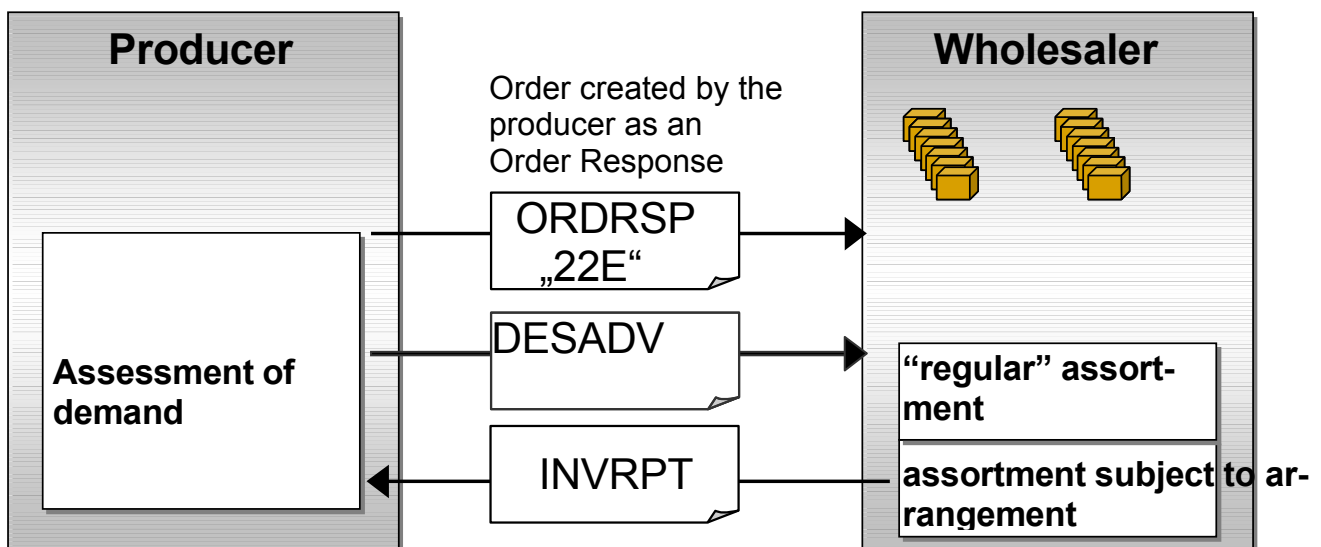

In addition to the information on quantity, the wholesaler may transfer to the producer an order number in the RFF-Segment in the head section of the INVRPT. This order number is assigned for one order which is created by the producer on the basis of the data transferred in the INVRPT. Thus, the wholesale trade has the opportunity to reference a delivery to an order number in his system.

The wholesaler is not informed about orders created by the producer by means of a separate ORDERS message. Instead, orders created by the producer are announced by an order response with Code 22E in the BGM-Segment. The order number previously transferred by the wholesale trade in the INVRPT will be used as the order number in the ORDRSP. If the INVRPT did not provide an order number from the wholesaler to the producer, an order number for ORDRSP will be created by the producer. The original message EDITEC-ORDRSP 3.0 was supplemented with the qualifier 22E in the BGM-Segment and published as Version 3.1.

The INVRPT does not transfer any information concerning the temporal demand of the wholesale trade. All quantities assigned that are transferred are **demanded for that immediate point in time**. In addition, the wholesaler has the opportunity to transfer his customer orders including the target date (e. g. Orders of the trade at the wholesalers) to the producer. For this purpose, Code 220 was added in the BGM-Segment of the message ORDERS. This code signifies that the order is not one of the wholesaler's directed at the producers, but a customer's order directed at the wholesaler. An ORDERS message with Code 220 in the BGM-Segment is thus not followed by a direct order. It merely serves the transfer of customer orders with a wished for target date.

If the "Open Orders (stock orders) (Code 73)" are transferred in the INVRPT instead of the "Goods Receipt Quantity (Code 48)", the wholesaler's open purchase orders quantity **for** the industry maybe transferred additionally as ORDERS with Code "248" (open orders stock at the industry).

The Qualifiers 220 for „Target Date Order Book“ and 248 for „Open Purchase Orders Quantity“ were added to the original ORDERS message and released as Version 3.1. With this piece of information, the industry may determine the „open rolling stock on hand“.

2.4 Terms Concerning the Inventory Report

In the following table, the terms used in the Stock of Inventory Report are defined:

Terms	Definition
Goods Receipt Quantity	A change in quantity affecting the inventory. All goods receipts processed per article on one day are summed up here. The last past goods receipt may be transferred. In addition, the date of the goods receipt may be transferred.
Open Orders (open orders stock)	In the open orders, <u>all</u> orders of the inventory subject to planning are summed up and transferred. The emergence of the order is not taken into account. This means that orders which have been taken by telephone or facsimile have to be transferred as well.
Minimal Stock	The minimal stock is bilaterally coordinated by wholesale trade and industry.
Maximal Stock	The maximal stock is bilaterally coordinated by wholesale trade and industry.
Goods Backlog (immediate delivery required)	The goods backlog is contained in the reserved quantity. With the delivery of the goods backlog, the complete demand detected by the producer should be delivered as an express delivery. The goods backlog transferred is always a positive value. (No negative values are transferred.)
Stock of Inventory (physical stock)	The goods physically on stock. (Stock of Inventory).
Reserved Quantity	The quantity reserved contains the customer orders to the wholesaler for n weeks. The number of weeks is defined by the wholesale trade.
Monthly Demand (proper code)	The monthly demand is the demand of the following four weeks, forecasted by the wholesaler. This code is used for the purpose of information only.

3 Recommendations/Examples for Practical Realisation

The following examples provide models for the practical realisation of this new business process. These model examples have already been put into practice in pilot projects between industry and wholesale trade. They are presently in use.

In line with the pilot projects, the following general approach for the processing and realisation of the business process may be given as a supporting guideline.

1. The transfer of inventory report data should follow a periodic schedule and be executed at a preassigned date (after daily closing).
2. Joint definition of the product assortment (wholesale trade and industry) and the necessary starting parameters (Minimal Stock(Min), Maximal Stock(Max), Packaging Units (VPE)).
3. Regulation of the mutual agreement in case of changes to the product assortment or the starting parameters.
4. Agreement on a process for escalation and an emergency concept.
5. Determination of bilateral agreements.
6. If the wholesaler wishes for an order response instead of the despatch advice DESADV, he should transfer a free order number from his enterprise resource planning system in the INVRPT for each referencing of a definite order number in the inventory report messages. If this is not possible, a number will be created and provided by the industry.
7. If for any article the code 143 is transferred in the segment QTY (Goods backlog (immediate delivery required)) of the inventory report data, the industry will provide a special delivery (express delivery) for these line items and deliver the whole acquired demand.
8. Customers' retractions of goods and internal movements of the inventory to the industry must not be reported as goods receipts. The increase of the physical stock of inventory of the wholesaler is shown in the transferred inventory report. Cumulative goods receipts between the last inventory report and the daily recent inventory report have to be reported.

9. Goods receipts or changes in the state of orders have to be accounted for automatically at the wholesaler's in the stock of inventory quantity. This means that a goods receipt leads simultaneously to a change of inventory for both the reported final daily inventory and the state of open orders. In case of partial deliveries, the quantity delivered has to be discounted from the quantity ordered.
10. When a goods receipt is reported, it has to include each product of the INVRPT. If only the actually effected goods receipts since the last transfer of the report period are reported, only those line items affected by the goods receipt in the report period are listed with goods receipt quantity and date.
11. For the differentiation of goods in stock (arranged by the industry) and goods on consignment, object business (Objektgeschäft) and procured products (arranged by the wholesale trade), two customer numbers at the industry's and two supplier numbers at the wholesaler's may be set up. A clear differentiation between goods in stock and goods on consignment respectively object business is mandatory in order to prevent double orders.

3.1 Model Examples

In the following, three different models concerning goods in stock/stocking-up supply (static or dynamic) are displayed:

1. Goods in stock/stocking-up supply I – with information on goods receipt;
2. Goods in stock/stocking-up supply II – with an open purchase order quantity
3. Goods in stock with order book/standard date order – with regard to Code 220.

Similarities of these models:

1. Data in INVRPT (mandatory fields) that has to be transferred independent of each model:
 - Stock of inventory (Code 145)
 - Reserved quantity (Code 216)
2. Standard parameters (are to be defined once at the beginning of the process)
 - maximal stock
 - minimal stock
 - packaging units
3. Despatch advice DESADV or order response ORDRSP with Code 22 E for the creation of an order at the wholesaler's.

3.2 Model 1: Goods in stock/Stocking-up supply with information on goods receipt

3.2.1 Data for Model 1

For model 1, the goods receipt quantity has to be transferred to the mandatory fields in the INVRPT. Optionally, the date of goods receipt may be transferred as well.

- Goods receipt quantity (Code 48)
- Goods receipt date (optional)

3.2.2 Rules for Model 1

- a) The industry has a rolling stock on hand. The write-off of the rolling stock (“goods on the way”) by the industry is executed by means of the feedback of the goods receipt quantity: All goods receipts per item that have been executed during the report period are summed up in one line item.
- b) Goods taken back or internal inventory movements to the industry are not to be reported as goods receipts. The increase of the physical stock of inventory of the wholesaler is shown in the transferred inventory report.
- c) Goods receipts have to be accounted for automatically at the wholesaler’s in the stock of inventory quantity.

3.3 Goods in Stock/Stocking-up Supply with Information on Goods Receipt

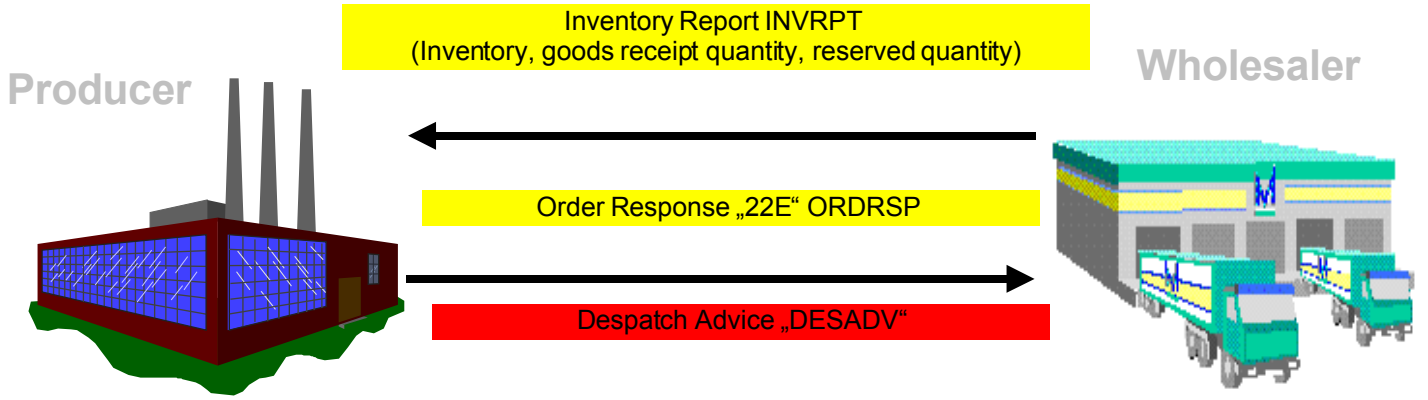

Attention!! Commission/Object Business/Procured Products

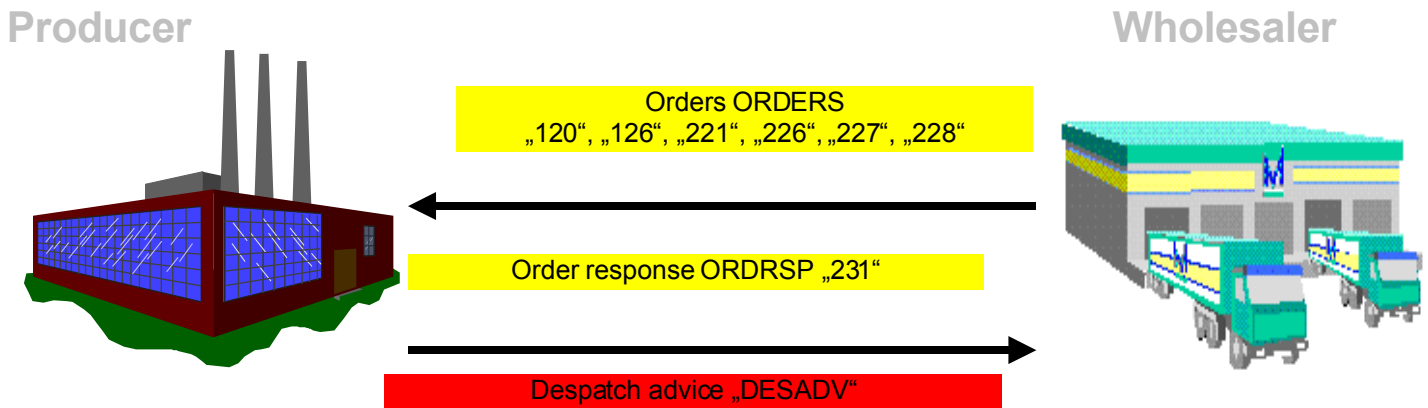

3.3 Model 2: Goods in Stock/Stocking-Up Supply with Open Purchase Order Quantity

3.3.1 Data for Model 2

For model 2 the open purchase order quantity has to be transferred to the mandatory fields in INVRPT.

- Open Purchase Order Quantity (Code 73)

3.3.2 Differences to Model 1:

Instead of the goods receipt quantity, the open purchase order quantity is transferred in INVRPT. By means of an additional ORDER message with code 248, the open purchase order quantity is transferred with the following pieces of information:

Open Purchase Order Quantity as ORDERS with BGM Code (248)

- Purchase order number of the wholesaler (BGM-Segment)
- Job account number / order number of the industry (RFF-Segment)
- Open line items (LIN-Segment) (the line item number in the LIN is the industry's line item number of the order)
- Open quantity ordered (QTY-Segment)
- Number of the inventory report

The activation of the order by the order response works analogue to model 1.

3.3.3 Rules Model 2

- a) The write-off of the by the industry is executed by means of the feedback of the open purchase order quantity.
- b) ATTENTION: In the transfer of the open purchase order quantity, all stock orders of the stock that has to be **planned/distributed/arranged** are summed up.
- c) Additionally, the open purchase order quantity maybe reported by the wholesaler as ORDERS on the level of orders (one Orders 248 per order).
- d) Goods taken back or internal inventory movements to the industry are not to be reported as open purchase order quantity. The increase of the physical stock of inventory of the wholesaler is shown in the transferred inventory report.
- e) Changes of the open purchase order quantity have to be accounted for automatically at the wholesaler's in the stock of inventory quantity.

3.4 Goods in Stock/Stocking-Up Supply with Open Purchase Order Quantity

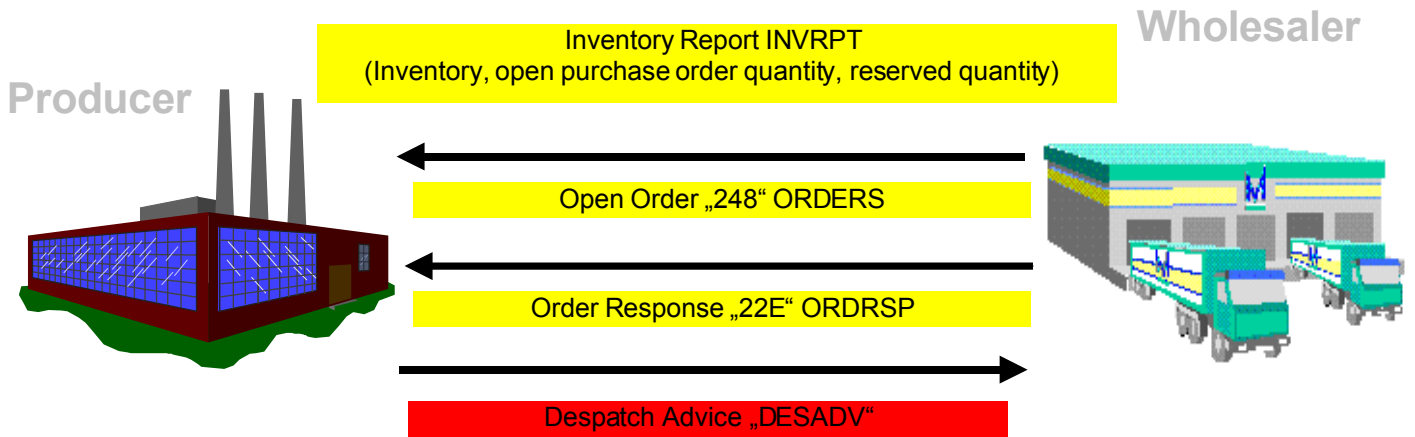

Attention!! Commission/Object Business/Procured Products

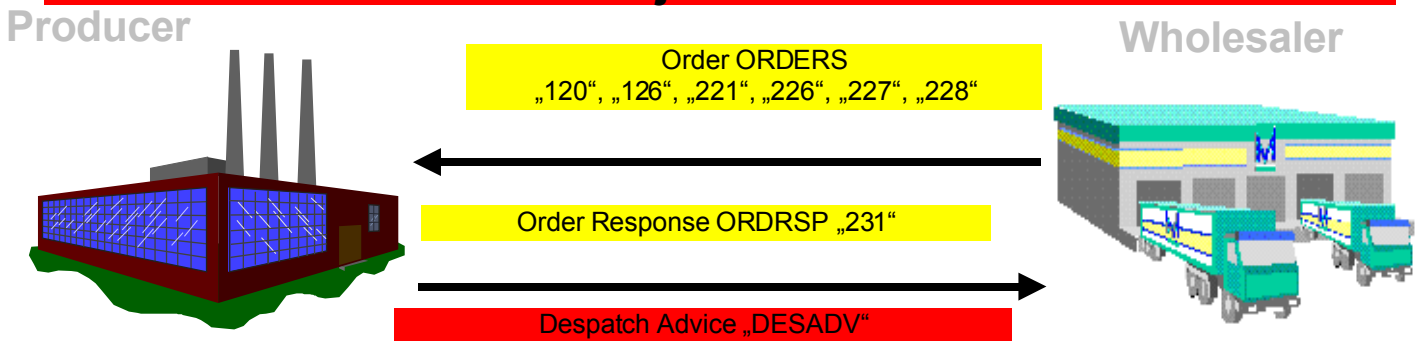

Modell 3: Goods in stock with Order Book/Standard Date Order

3.3.4 Data for Model 3

For model 3 the goods receipt quantity has to be transferred to the mandatory fields in the INVRPT. Optionally, the date of goods receipt maybe transferred as well.

- Goods receipt quantity (Code 45)
- Goods receipt date (optional)

3.3.5 Differences to Model 1 and Model 2

Model 3 is a supplement to Model 1. In comparison to Model 2, it is not the open purchase orders quantity that is transferred with the orders message. Instead, the orders message with code 220 transfers the orders of the wholesaler's customers to the producer. They also include the wished for dates of delivery.

Order book/Standard Date Order as ORDERS with BGM Code (220)

- Order number of the wholesaler (BGM-Segment)
- Date of delivery(Head) (DTM-Segment)
- Article line items (LIN-Segment)
- Ordered quantity (QTY-Segment) ***

*** = the ordered quantity is not transferred as a reserved quantity in the INVRPT

The activation of the order by the order response works analogue to model 1 and model 2.

3.3.6 Rules Model 3

- a) The write-off of the rolling stock (goods on the way) by the industry is executed by means of the feedback of the goods receipt quantity and the date of goods receipt.
- b) ATTENTION: All goods receipts processed per article in the report period are summed up in this line item.
- c) Goods taken back or internal inventory movements to the industry are not to be reported as goods receipts. The increase of the physical stock of inventory of the wholesaler is shown in the transferred inventory report.
- d) Goods receipts have to be accounted for automatically at the wholesaler's in the stock of inventory quantity.
- e) Procured Products are defined with the starting parameters MIN=0, MAX=0 VPE=1.

Goods in Stock with Order Book/Standard Date Order

Producer

Wholesaler

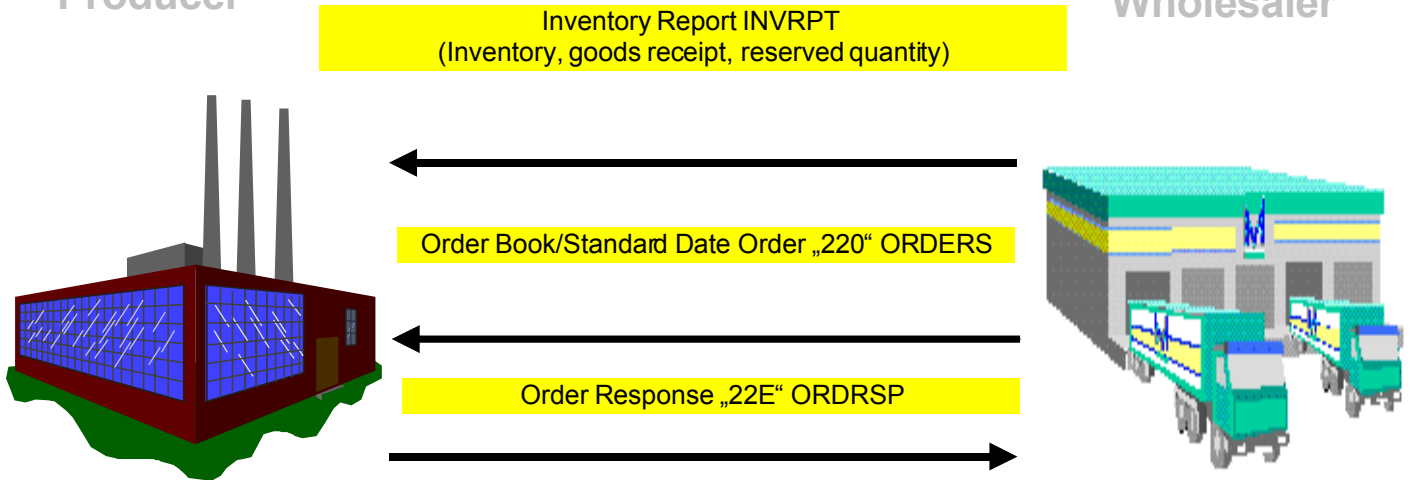

Note: The customer order is to be found as either a reserved quantity in INVRPT or in the order book (quantity, product, date). The order book has the advantage, that a customer order (e. g. the customer wished for a date within four weeks) is displayed to the producer. Thus, the producer may account for this customer order at an early stage of planning. If the wholesale trade would already reserve the goods for this customer order at that day, consequently, there could be no guarantee that further new orders from other customers could be satisfied immediately.

4 Lagerbestandbericht von Industrie an Handel

4.1 Zweck

Zur Übertragung geänderter Mindest- und Maximalbestände durch die Industrie kann die Nachricht INVRPT mit dem Code 35E für „Lagerbestandsmeldung von Industrie an Handel“ genutzt werden. Im Rahmen dieser Übertragung werden auf Positionsebene im QTY-Segment neue Mindest- und Maximalbestände übertragen, die ab diesem Zeitpunkt verwendet werden.

In einem neuen DTM-Segment kann je Artikel die Wiederbeschaffungszeit angegeben werden.

4.2 Anwendungsbeispiel / Notwendigkeit